



DESCRIPTION:

With high ability to withstand the shock loading of large current, TYN40H-1600SJ SCR provides high dV/dt rate with strong resistance to electromagnetic interference. It is especially recommended for use on solid state relay, UPS, SVC, power charger, T-tools etc. Package TO-247J is RoHS compliant.

MAIN FEATURES

Symbol	Value	Unit
$I_{T(AV)}$	40	A
V_{DRM}/V_{RRM}	1600	V
I_{GT}	10-80	mA

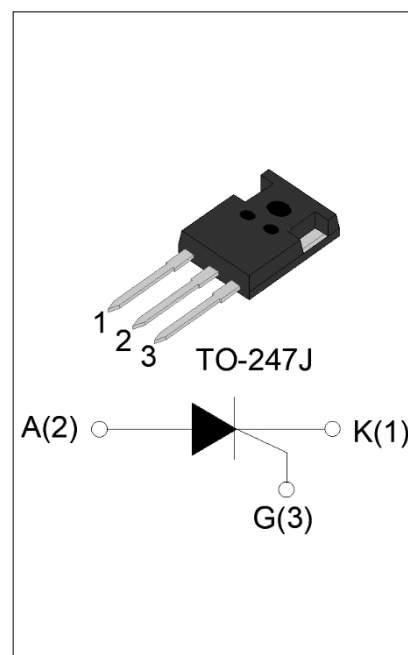

ABSOLUTE MAXIMUM RATINGS

Parameter	Symbol	Value	Unit
Storage junction temperature range	T_{stg}	-40-150	°C
Operating junction temperature range	T_j	-40-150	°C
Operating temperature range	T_{op}	-40-125	°C
Repetitive peak off-state voltage ($T_j=25^\circ\text{C}$)	V_{DRM}	1600	V
Repetitive peak reverse voltage ($T_j=25^\circ\text{C}$)	V_{RRM}	1600	V
Average on-state current ($T_c \leq 90^\circ\text{C}$)	$I_{T(AV)}$	40	A
RMS on-state current ($T_c \leq 90^\circ\text{C}$)	$I_{T(RMS)}$	63	A
Non repetitive surge peak on-state current ($t_p=10\text{ms}$, $T_j=25^\circ\text{C}$)	I_{TSM}	650	A
Non repetitive surge peak on-state current ($t_p=8.3\text{ms}$, $T_j=25^\circ\text{C}$)		715	
I^2t value for fusing ($t_p=10\text{ms}$, $T_j=25^\circ\text{C}$)	I^2t	2113	A^2s
Critical rate of rise of on-state current ($I_G=2 \times I_{GT}$, $f=100\text{Hz}$, $T_j=150^\circ\text{C}$)	di/dt	200	$\text{A}/\mu\text{s}$
Peak gate current ($t_p=20\mu\text{s}$, $T_j=150^\circ\text{C}$)	I_{GM}	12	A

Average gate power dissipation ($T_j=150^{\circ}\text{C}$)	$P_{G(AV)}$	1	W
Peak gate power	P_{GM}	22	W
Peak pulse voltage ($T_j=25^{\circ}\text{C}$; non-repetitive, off-state; FIG.7)	V_{pp}	1.2	kV

ELECTRICAL CHARACTERISTICS ($T_j=25^{\circ}\text{C}$ unless otherwise specified)

Symbol	Test Condition	Value			Unit
		MIN.	TYP.	MAX.	
I_{GT}	$V_D=12\text{V } R_L=33\Omega$	10	-	80	mA
V_{GT}		-	-	1.3	V
V_{GD}	$V_D=V_{DRM} T_j=150^{\circ}\text{C } R_L=3.3\text{K}\Omega$	0.25	-	-	V
I_L	$I_G=1.2I_{GT}$	-	-	250	mA
I_H	$I_T=500\text{mA}$	-	-	200	mA
dV/dt	$V_D=1070\text{V}$ Gate Open $T_j=150^{\circ}\text{C}$	2000	-	-	V/ μs
t_{on}	$I_G=100\text{mA } I_A=1\text{A } I_R=100\text{mA}$ $T_j=25^{\circ}\text{C}$	-	10	-	μs
t_{off}		-	150	-	

STATIC CHARACTERISTICS

Symbol	Parameter		Value(MAX.)	Unit
V_{TM}	$I_{TM}=80\text{A } t_p=380\mu\text{s}$	$T_j=25^{\circ}\text{C}$	1.7	V
V_{TO}	Threshold voltage	$T_j=150^{\circ}\text{C}$	0.8	V
R_D	Dynamic resistance	$T_j=150^{\circ}\text{C}$	10	m Ω
I_{DRM}	$V_D=V_{DRM} V_R=V_{RRM}$	$T_j=25^{\circ}\text{C}$	20	μA
I_{RRM}		$T_j=150^{\circ}\text{C}$	10	mA

THERMAL RESISTANCES

Symbol	Parameter	Value	Unit
$R_{th(j-c)}$	junction to case(DC)	0.6	$^{\circ}\text{C/W}$
$R_{th(j-a)}$	junction to ambient (DC)	50	$^{\circ}\text{C/W}$

ORDERING INFORMATION

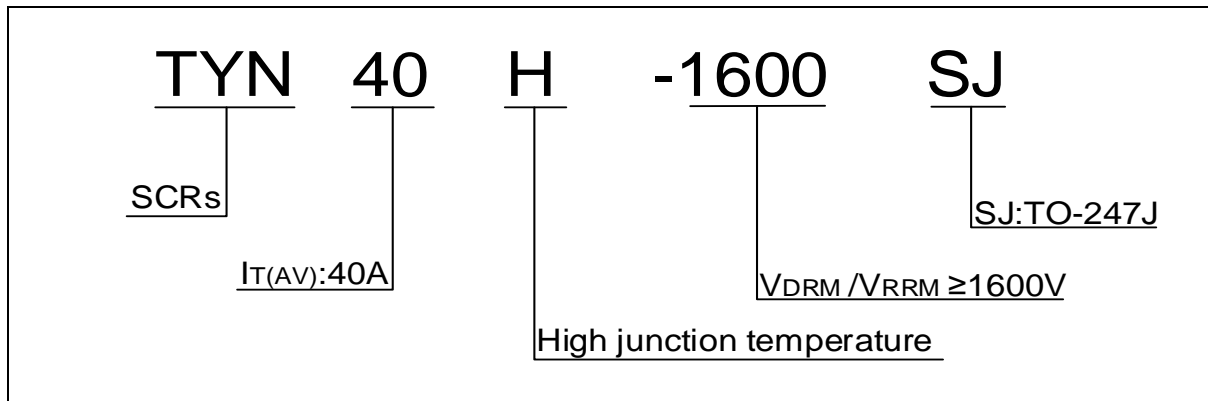

MARKING

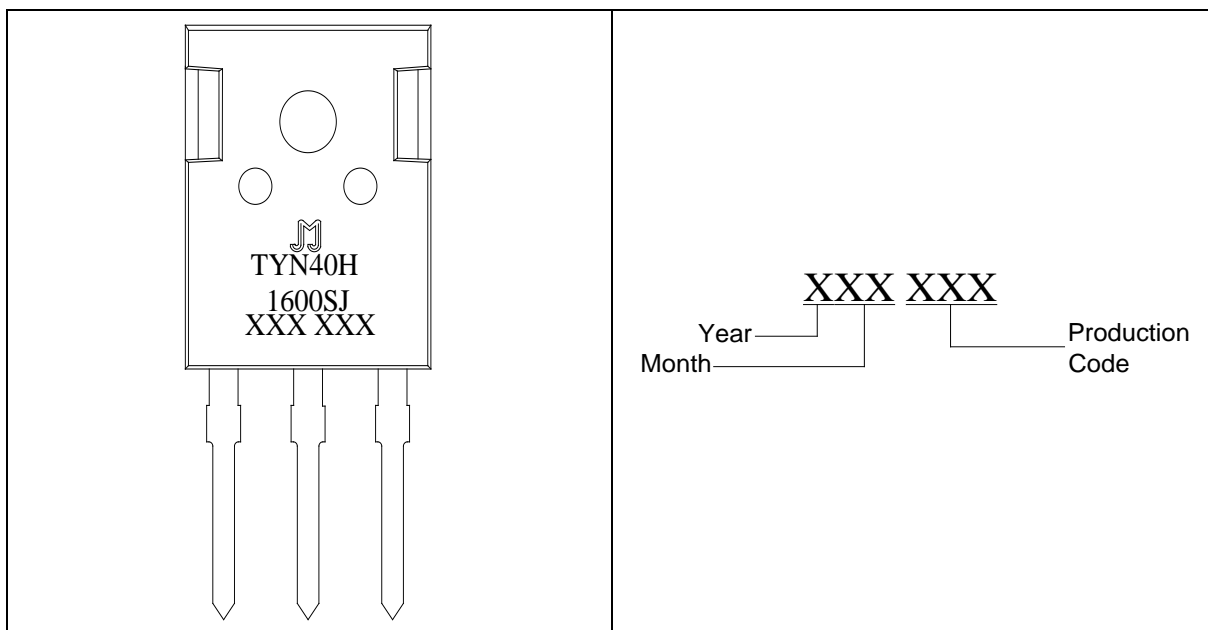

FIG.1: Maximum power dissipation versus RMS on-state current

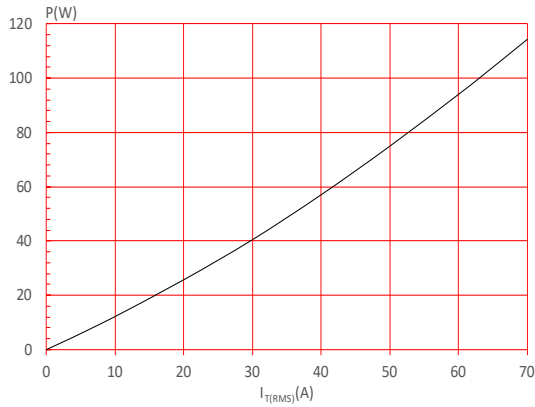

FIG.2: RMS on-state current versus case temperature

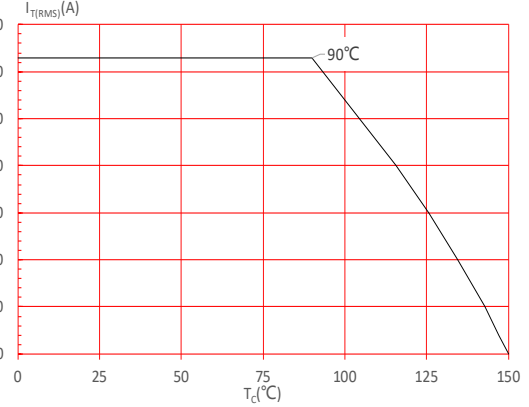

FIG.3: Surge peak on-state current versus number of cycles

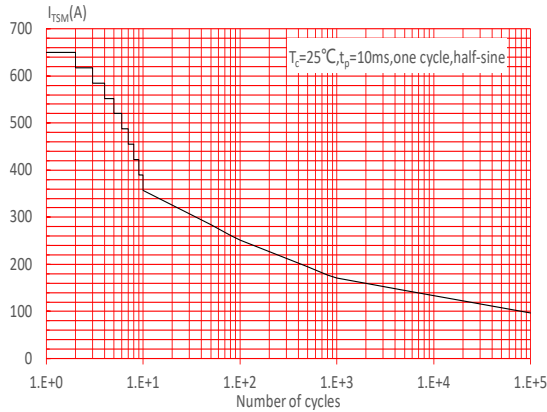

FIG.4: On-state characteristics

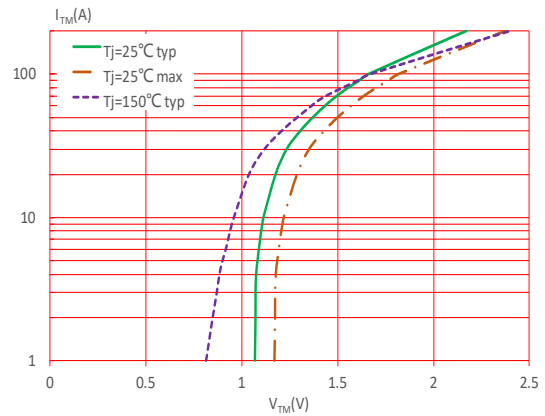

FIG.5: Non-repetitive surge peak on-state current for a sinusoidal pulse with width $t_p < 10\text{ms}$, and corresponding value of I^2t ($di/dt < 200\text{A}/\mu\text{s}$)

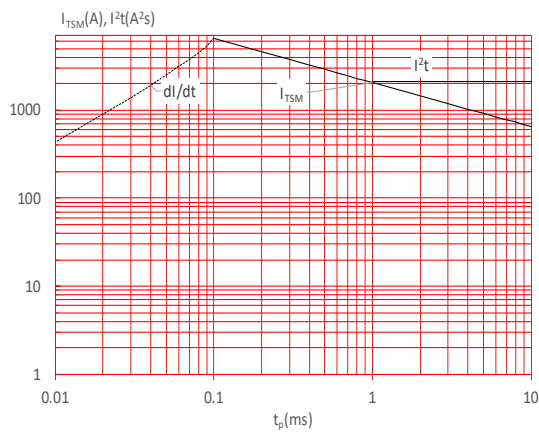

FIG.6: Relative variations of gate trigger current, holding current and latching current versus junction temperature

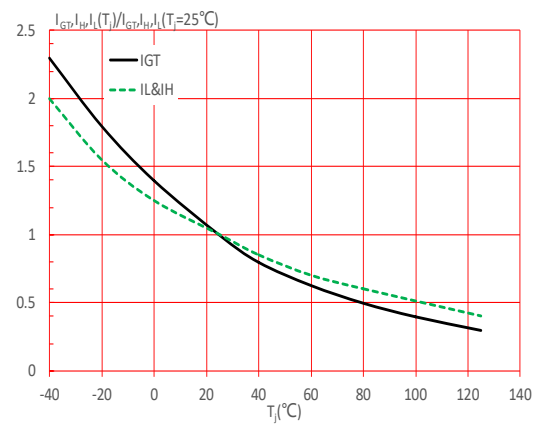
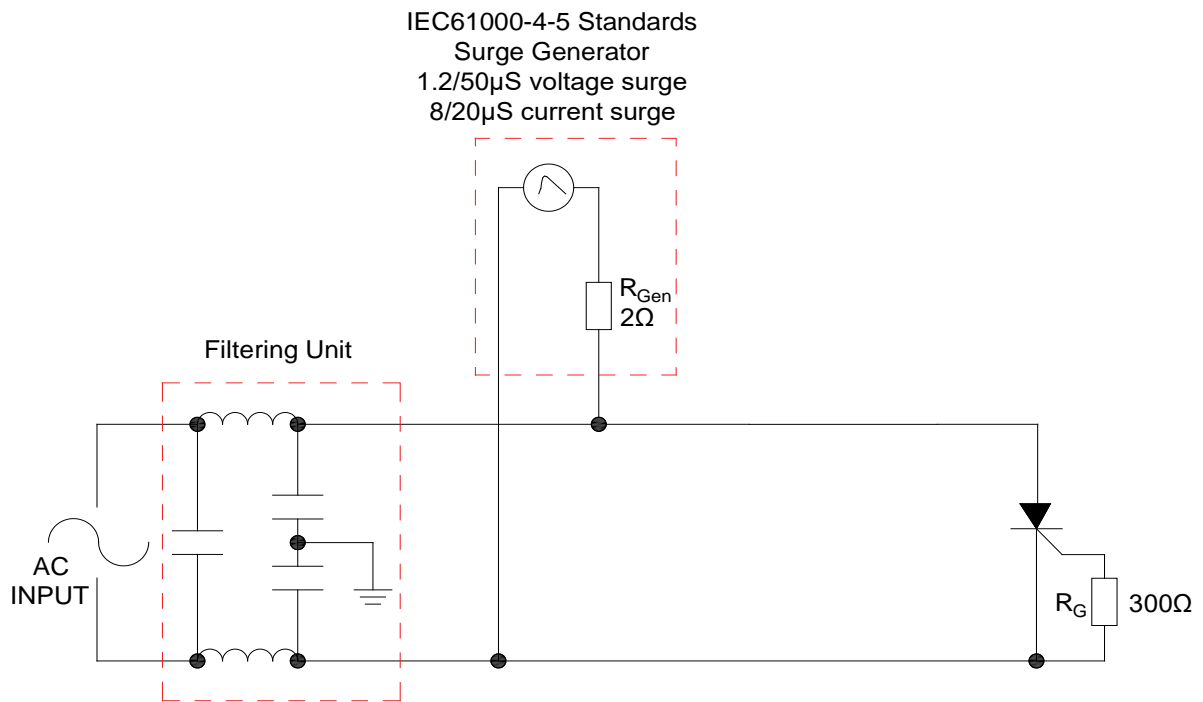

FIG.7: Test circuit for inductive and resistive loads to IEC-61000-4-5 standards.



LEAD FORMING AND SOLDERING

Refer to the application note “Assembly Instructions for Power Discretes in Through-hole Packages” released by JieJie Microelectronics

ORDERING INFORMATION

Order code	Voltage V_{DRM}/V_{RRM} (V)	IGT(mA)	Package	Base qty. (pcs)	Delivery mode
TYN40H-1600SJ	1600	10-80	TO-247J	30	Tube

Document Revision History

Date	Revision	Changes
Apr.13, 2023	A.1.0	Last update
Jan.9, 2025	A.2.0	Update Package

PACKAGE MECHANICAL DATA

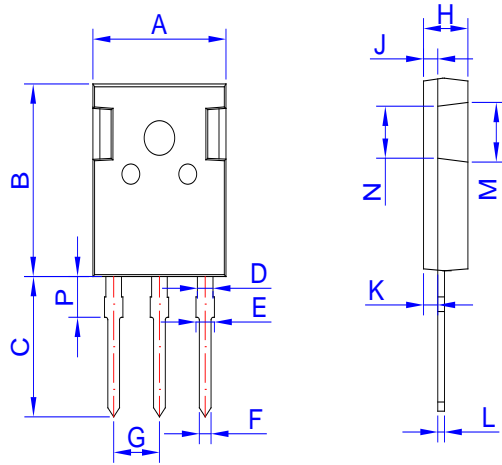

Ref.	Dimensions					
	Millimeters			Inches		
	Min.	Typ.	Max.	Min.	Typ.	Max.
A	15.50	15.80	16.10	0.610	0.622	0.634
B	20.80	21.00	22.20	0.819	0.827	0.835
C	19.70	20.00	20.30	0.776	0.787	0.799
D	1.80	2.00	2.20	0.071	0.079	0.087
E	1.90	2.10	2.30	0.075	0.083	0.091
F	1.00	1.20	1.40	0.039	0.047	0.055
G		5.44			0.214	
H	4.80	5.00	5.20	0.189	0.197	0.205
J	1.90	2.00	2.10	0.075	0.079	0.083
K	2.20	2.35	2.50	0.087	0.093	0.098
L	0.41	0.60	0.79	0.016	0.024	0.031
M	3.70	3.80	3.90	0.146	0.150	0.154
N	3.55	3.60	3.70	0.140	0.142	0.146
P	4.05	4.15	4.25	0.159	0.163	0.167

DELIVERY MODE

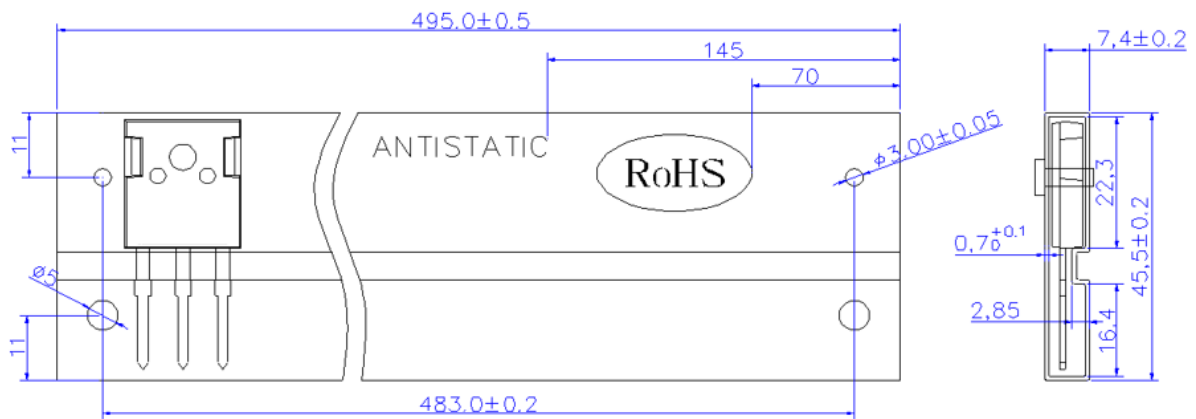

PACKAGE	OUTLINE	TUBE (PCS)	INNER BOX (PCS)	PER CARTON
TO-247J	TUBE	30	450	2,250

Information furnished in this document is believed to be accurate and reliable. However, Jiangsu JieJie Microelectronics Co., Ltd. assumes no responsibility for the consequences of use without consideration for such information nor use beyond it. Information mentioned in this document is subject to change without notice, apart from that when an agreement is signed, Jiangsu JieJie complies with the agreement. Products and information provided in this document have no infringement of patents. Jiangsu JieJie assumes no responsibility for any infringement of other rights of third parties which may result from the use of such products and information. This document supersedes and replaces all information previously supplied.

 is a registered trademark of Jiangsu JieJie Microelectronics Co., Ltd. Copyright © 2025 Jiangsu JieJie Microelectronics Co., Ltd. All rights reserved.